



Small Pressure Gauges

OUTLINE

This is a pressure gauge for measuring pressure of small machines and of pneumatic apparatus. An entire apparatus can be constructed smaller by using this pressure gauge. Additionally, such models as an eccentric type pressure gauge and a glycerine-bath type pressure gauge demonstrating high vibration resistance and a pressure gauge made of stainless steel (SUS) demonstrating high corrosion resistance are provided, allowing any selection appropriate for each usage.

FEATURES

- This gauge can be installed even in a limited space because of its small and light weight construction.
- Although it is of small type, this pressure gauge is equipped with an indication portion easy to read.
- * In case of selecting pressure gauge, choose the pressure range which can be used in between 30 ~ 65% of full scale, so that the gauge can give its full capacity.
- * Also should be confirmed whether the wetted parts material is suitable for the fluid or not.

SPECIFICATION

Fluid:

Air or liquid (Non-corrosive fluid only)

Operating condition:

Under the normal condition, corrosive liquid or gas should not be existry.

Class:

Class A or class B

Class A gauge ia used for pressure measurement of pneumatic equipment and is high grade gauge with Running test. class B is general purpose gauge for general use .

[Running test] Between zero and max.pressure, repeat in creasing and decreasing pressure and check the pointer movement.

Size:

40 DIA., 50 DIA.

Mounting:

Stem  Type A

Panel  Type D

Wetted parts material:

Bourdon tube C6872T
Socket C3604BD

Connection:

40 DIA. R1/8 (PT)
* R1/4 or 1/4 NPT is available.
50 DIA. R1/4 (PT)
* R1/8 or 1/8 NPT is available.

Pressure range:

0 ~ 0.1MPa → 0 ~ 3.5MPa

Accuracy:

±1.5%F. S. , ±2.0%F. S. , ±3.0%F.S.
(Depend on model)

Operating temperature:

-5 ~ 40°C (But fluid should not be frozen)

Scale angle:

Class A 40 DIA. 180°
Class A 50 DIA., class B 40 DIA., 50 DIA. 270°

Finishing :

Class A Cr plating
Class B 304 st.st.

Weight:

Class A 40 DIA. Approx. 75g
Class A 50 DIA. Approx. 165g
Class B 40 DIA. Approx. 60g
Class B 50 DIA. Approx. 95g

CONSTRUCTION

Class A 40 DIA. · 50 DIA.

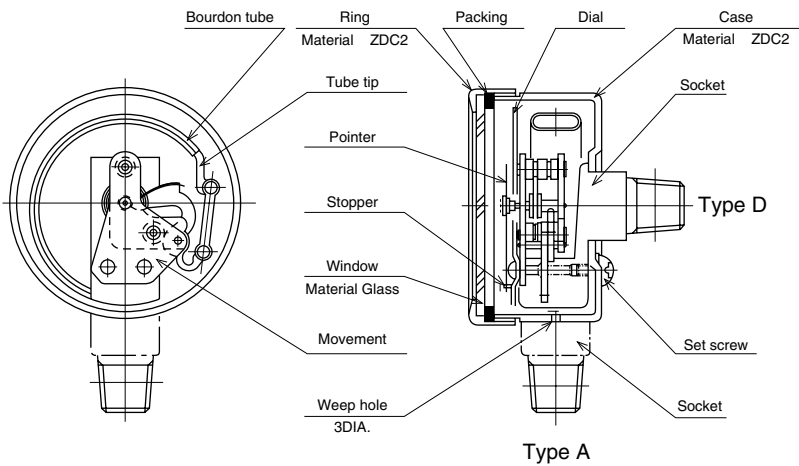

Treatment (Option):

Use no oil · water
Produce it to be not oil or water in wetted parts.

Dial scale specified (Option):

Dial scale specified produces such as Printed words, Customer's logo, Red line, Red marking as an option.

Class B 40 DIA. · 50 DIA.

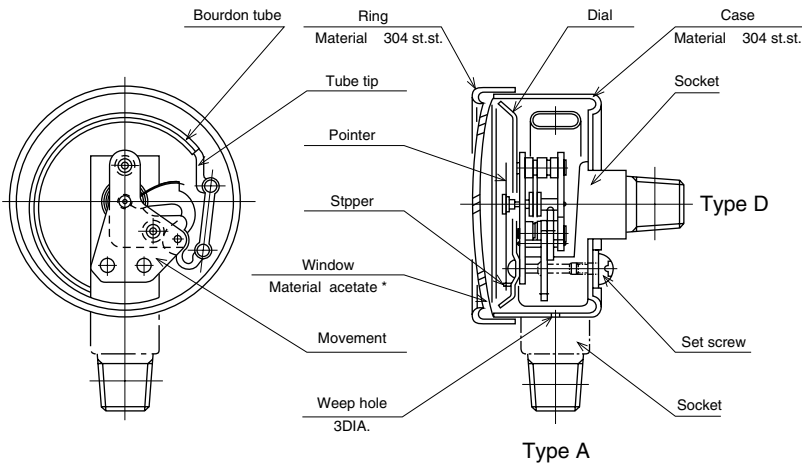

* Acetate (Acetic acid cellulose)

It isn't affected to a mineral, vegetable oil, carbon tetrachloride, and pay attention to ketone class, ethyl acetate, lactic acid ethyl, chloroform, mineral acid class because it is affected.

DIMENSION (Unit: mm)

Class A

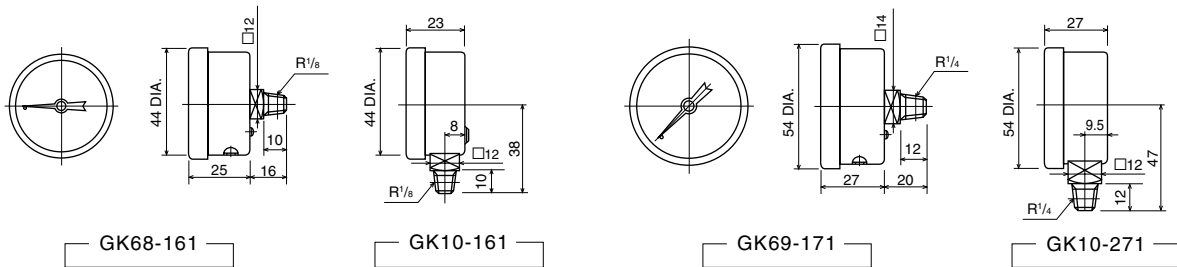

Class B

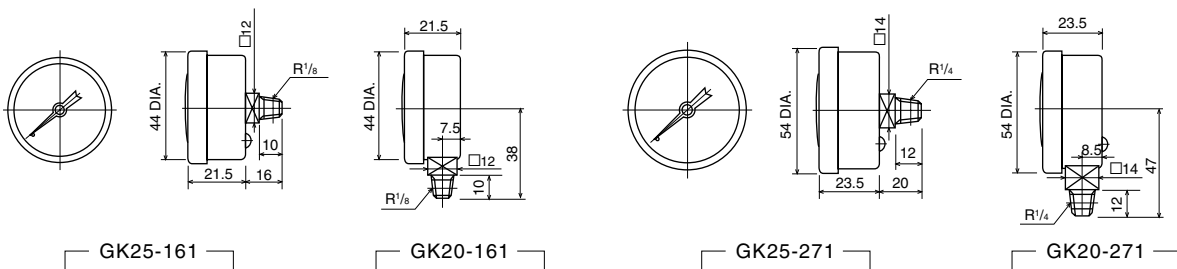

VARIOUS CHARACTERISTICS

Durability

Pressure gauge life varies according to conditions (vibration, surge pressure, temperature and others) pressure gauges are used. As an example, when a sine wave type pulsation in a constant cycle repeats itself in the pressure range 20% to 80% of the working range, the initial precision decreases as shown in the right figure

(Fig. D1)

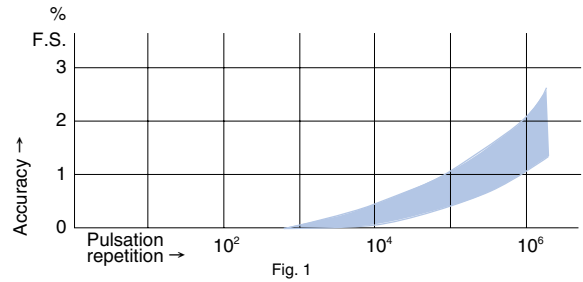

Fig. 1

Temperature Characteristics

Small pressure gauges demonstrate a precision change of 0.5% to 2.5% F. S. at 20°C±60°C according to the comprehensive changes including the elastic coefficient change of a Bourdon tube and the expansion rate change due to the part thermal expansion stemmed from ambient temperature.

(Fig. 2)

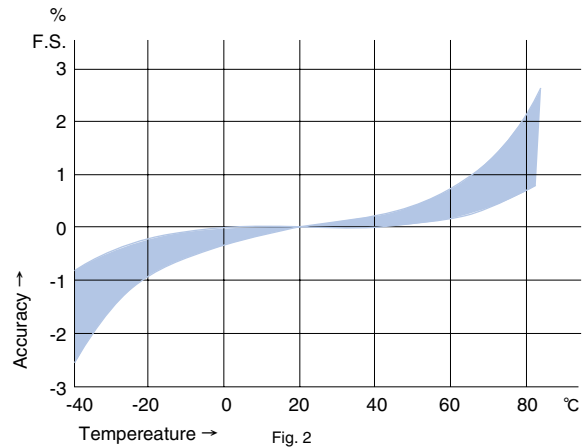

Fig. 2

Vibration Durability

Small pressure gauges are advantageous to use in places with vibrations because of small parts. On the contrary, as they require high-precision elements, to keep their precision longer it is advisable to avoid usage in not only places near their resonance point but also in places with vibration. Especially, do not use them in an environment with an acceleration of 4.9 m/s² or larger.

Note) The above data is for reference only. No guarantee for the performance exists.

Maintenance of Small Pressure Gauges

It is advisable to pay attention to the following points because small gauge performance is classified as normal in the JIS and they are small and precision instruments.

- ① Do not give pressure gauge mechanical vibrations and pulsation.
- ② Keep ambient temperature in the range of -5°C to 40°C.
In direct sunshine in summer, ambient temperature easily increases, requiring a cover and others.
In winter, pay attention to measuring liquid not to freeze.
- ③ Absolutely avoid a corrosive environment and corrosive measuring liquid.
- ④ Protect pressure gauges sufficiently from rain and mist.
- ⑤ Perform inspection approximately once a year, according to the grade of importance.

OTHER SMALL PRESSURE GAUGE

(Vibration-proof type)

Eccentric type pressure gauge (GK90)

Suitable for mechanical vibration or pulsation. Scale angle is smaller than other model.



Fluid: Air or liquid (Non corrosive fluid only)

Size: 40 DIA., 50DIA.

Mounting: Stem . . .  Type A

Connection: R1/8 (PT), R1/4 (PT)

Wetted parts material: Socket C3604BD
Bourdon tube C6872T

Pressure range (And minimum graduation):
0 ~ 1.5MPa (0.1MPa)
0 ~ 3.5MPa (0.5MPa)

Accuracy: ±5%F. S.

Scale angle: 60°

Case material · finishing: 304 st. st. · The material

Weight: Approx. 100g

Glycerine bath type pressure gauge (GK75)

Glycerine is filled in a gauge and suitable for mechanical vibration or pulsation.



Fluid: Air or liquid (Non corrosive fluid only)

Size: 40 DIA., 50 DIA.

Mounting: Panel . . .  Type D

Connection: R1/8(PT), R1/4(PT)

Wetted parts material: Socket CAC203
Bourdon tube C6872T

Pressure range:
40 DIA. 0 ~ 0.2 → 0 ~ 1.5MPa
50 DIA. 0 ~ 0.2 → 0 ~ 3.5MPa

Accuracy: ±3%F. S.

Scale angle: 40 DIA. 180°
50 DIA. 270°

Case material · finishing: ZDC2 · Cr plating

Weight : 40 DIA. Approx. 150g
50 DIA. Approx. 250g

(Corrosion-proof type)



Pressure gauge with st. st. (GK33 · 38):

Case and wetted parts are stainless steel, so superior to corrosion.



Fluid: Air or liquid

Size: 50 DIA.

Mounting: Stem  Type A
(Model: GK33)
Panel  Type D
(Model: GK38)

Connection: R1/8 (PT), R1/4 (PT)

Wetted parts material: Socket (Model: GK33) 316 st. st.
(Model: GK38) SCS14
Bourdon tube 316 st. st.

Pressure range:
0 ~ 0.1 → 0 ~ 28MPa

Accuracy: ±3%F. S.

Scale angle: 270° (0.1MPa range 180°)

Case material · finishing: 304 st. st. · The material

Weight: Approx. 100g

Type No. constitution Please specify Type No.,each specification and range, when ordering.

Note: For this Model,there is no applicable item for the figures X,but please specify with X when ordering.

Class	Size	Type · Connection		Accuracy (%F.S.)	Scale angle				
A	40 DIA.	G K 6 8 — 1 6 1	Type D R1/8	1	0 - 0.2, 0.4, 0.7, 1MPa	2.0	180°		
		G K 1 0 — 1 6 1	Type A R1/8	1	0 - 0.2, 0.4, 0.7, 1MPa				
	50 DIA.	G K 6 9 — 1 7 1	Type D R1/4	2	0 - 0.2, 0.4, 0.7, 1, 1.5MPa	1.5	270°		
		G K 1 0 — 1 7 1	Type A R1/4	3	0 - 2, 2.5, 3.5MPa				
B	40 DIA.	G K 2 5 — 1 6 1	Type D R1/8	1	0 - 0.1MPa			3.0	270°
		G K 2 0 — 1 6 1	Type A R1/8	2	0 - 0.2, 0.4, 0.7, 1MPa				
	50 DIA.	G K 2 5 — 2 7 1	Type D R1/4	1	0 - 0.1MPa				
		G K 2 0 — 2 7 1	Type A R1/4	2	0 - 0.2, 0.4, 0.7, 1MPa				

Model 1 · 2 · 3 Type · Connection 4 Pressure range (MPa)

(When ordering,please specify pressure range & unit.)

Small pressure gauges

GK

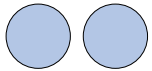

Type No.

Selection spec.

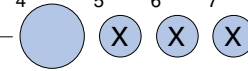

Additional spec. (option)

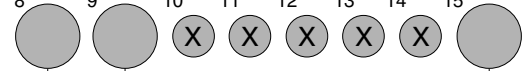

8 Treatment

- 0 Nil
- 1 Use no oil
- 2 Use no water
- 3 Use no oil · water

9 Other additional spec.

- 0 Nil
- 1 Please specify your requirement
Socket, Ni plating
Dial scale specified
Case color required
Connection NPT

15 Document

- 0 Nil
- 1 Please specify your requirement
Drawing one sheet, Instruction manual
Inspection procedure, Mill sheet
Test report